

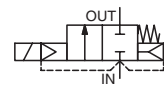

SOLENOID VALVES

pilot operated
hung diaphragm, gaseous fluids
3/8 to 3

NC



NO

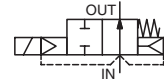

2/2
Series
215

FEATURES

- The valves are for the control of low pressure air and gases, compatible with the seal materials used
- Aluminium bodied valves designed to provide maximum flow
- The valve have a resilient soft seating for tight shut-off
- Valves do not require a minimum operating pressure
- All products are covered by Pressure Equipment Directive 2014/68/EU and are suitable for group 1 and 2 fluids
- The solenoid valves satisfy all relevant EU directives

GENERAL

Differential pressure
Response time

See «SPECIFICATIONS» [1 bar =100 kPa]
25 - 120 ms

fluids (*)	temperature range (TS)	seal materials (*)
air, fuel gas NC: inert gas	-20°C to +85°C	NBR (nitrile)

MATERIALS IN CONTACT WITH FLUID

(*) Ensure that the compatibility of the fluids in contact with the materials is verified

Body	Aluminium
Core tube	Stainless steel
Core and plugnut	Stainless steel
Springs	Stainless steel
Seat	Aluminium or stainless steel
Seals, diaphragms & discs	NBR
Core guide	POM
Disc holder (NO function)	PA
Rider rings	PTFE
Shading coil	Copper

ELECTRICAL CHARACTERISTICS

Coil insulation class F
Connector Spade plug (cable Ø 6-10 mm) or cable leads, 0,35 m length (EF)

Connector specification ISO 4400 / EN 175301-803, form A

Electrical safety IEC 335

Electrical enclosure protection Moulded IP65 (EN 60529) or NEMA 3, 7, 9 (EF)

Standard voltages DC (=) : 24V - 48V

(Other voltages and 60 Hz on request) AC (~) : 24V - 48V - 115V - 230V / 50 Hz

prefix option	power ratings				operator ambient temperature range (TS) (C°)	replacement coil		type ⁽¹⁾
	inrush ~	holding ~	hot/cold =			~	=	
	(VA)	(VA)	(W)	(W)		230 V/50 Hz	24 V DC	
SC	55	23	10,5	9/ 11,2	-20 to +75	400425-117	400425-142	01
	110	33,6	15,4	-	-20 to +75	400525-117	-	02
EF	385	50	28,2	11/14,9	-20 to +75	206409-035D	062691-002D	03

⁽¹⁾ Refer to the dimensional drawings on the following page.

SPECIFICATIONS

pipe size	orifice size	flow coefficient Kv		operating pressure differential (bar)				power coil (W)		catalogue number		options			
				min.	max. (PS)		FPM					CR	-		
					air (*)	fuel gas (*)									
Rp	(mm)	(m³/h)	(l/min)	~	=	~	=	~	=	~	=	~	=		
NC - Normally closed															
3/8	19	2,9	48,3	0	3,5	1,8	3,5	1,8	10,5	11,2	SCE215C010 ⁽⁴⁾	SCE215C010 ⁽⁴⁾	V	J	-
1/2	19	3,8	63,3	0	3,5	1,8	3,5	1,8	10,5	11,2	SCE215C020 ⁽⁴⁾	SCE215C020 ⁽⁴⁾	V	J	-
3/4	19	4,4	73,3	0	3,5	1,8	3,5	1,8	10,5	11,2	SCE215C030 ⁽⁴⁾	SCE215C030 ⁽⁴⁾	V	J	-
1	41	18	300	0	1,8	1,8	1,8	1,8	15,4	14,9	SCE215B050	EFE215B050 ⁽²⁾	V	J	-
1 1/4	41	27	450	0	1,8	1,8	1,8	1,8	15,4	14,9	SCE215B060	EFE215B060 ⁽²⁾	V	J	-
1 1/2	41	30	500	0	1,8	1	1,8	1	15,4	14,9	SCE215B070	EFE215B070 ⁽²⁾	V	J	-
2	53	50	833	0	1,8	1	1,8	1	15,4	14,9	SCE215B080	EFE215B080 ⁽²⁾	V	J	-
2 1/2	76	100	1667	0	0,35	-	0,35	-	28,2	-	EFE215A090 ⁽²⁾	-	V	J	-
3	76	118	1967	0	0,35	-	0,35	-	28,2	-	EFE215A040 ⁽²⁾	-	V	J	-
NO - Normally open															
3/8	19	2,7	45	0	9	9	9	9	10,5	11,2	SCE215A013	SCE215A013	V	J	-
1/2	19	3,4	56,7	0	9	9	9	9	10,5	11,2	SCE215A023	SCE215A023	V	J	-
3/4	19	3,9	65	0	9	9	9	9	10,5	11,2	SCE215A033	SCE215A033	V	J	-
1	41	18	300	0	1,8	1	1,8	1	15,4	14,9	SCE215C053	EFE215C053 ⁽³⁾	V	J	-
1 1/4	41	28	450	0	1,8	1	1,8	1	15,4	14,9	SCE215C063	EFE215C063 ⁽³⁾	V	J	-
1 1/2	41	31	500	0	1,8	1	1,8	1	15,4	14,9	SCE215C073	EFE215C073 ⁽³⁾	V	J	-
2	53	50	833	0	1,8	1	1,8	1	15,4	14,9	SCE215C083 ⁽²⁾	EFE215C083 ⁽²⁾⁽³⁾	V	-	-
2 1/2	76	100	1667	0	0,35	-	0,35	-	28,2	-	EFE215B093 ⁽²⁾	-	V	-	-

⁽²⁾ Mounting position: piping horizontal, solenoid upright.

⁽⁴⁾ Valves have stainless steel seat.

⁽³⁾ Lead connection coil on DC.

All leaflets are available on: www.asco.com

V385-1

C

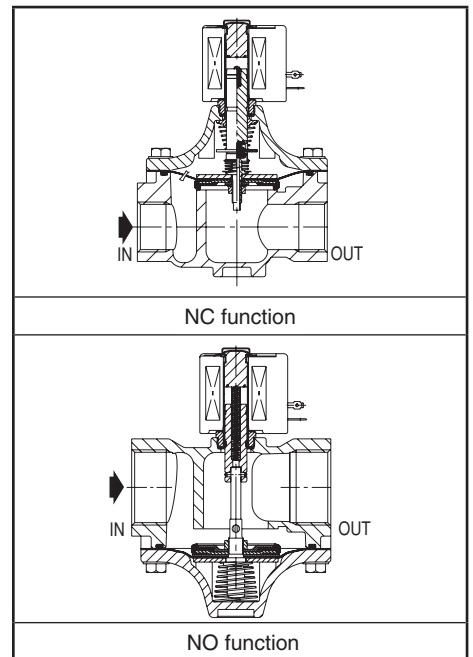

OPTIONS

- Valves can also be supplied with FPM (fluoroelastomer) and CR (chloroprene) diaphragms, seals and discs. Use the appropriate optional suffix letter for identification
- Waterproof enclosure with embedded screw terminal coil according to protection class IP67, CEE-10
- Explosionproof enclosures for use in zones 1/21-2/22, categories 2-3 to ATEX Directive 2014/34/EU (see "Explosionproof solenoids" section)
- Electrical enclosures according to "NEMA" standards are available
- Compliance with "UL", "CSA" and other local approvals available on request
- Mounting brackets (3/8, 1/2 and 3/4 only), suffix MB
- Other pipe connections are available on request
- Plug with visual indication and peak voltage suppression or with cable length of 2 m (see Solenoids, Coils & Accessories section)

INSTALLATION

- The solenoid valves can be mounted in any position without affecting operation, unless indicated otherwise in the specifications table.
- Pipe connection identifier is E = Rp (ISO 7/1)
- Installation/maintenance instructions are included with each valve

SPARE PARTS KIT & ACCESSORIES

catalogue number	spare parts kit no.		mounting bracket no.
	~	=	
SCE215C010/C020/C030	C302350	C302430	038713-000
SCE215B050/B060/B070	C302352	-	-
EFE215B050/B060/B070	-	C302432	-
SCE215B080	C302353	-	-
EFE215B080	-	C302433	-
EFE215A090/A040	C302354	-	-
SCE215A013/A023/A033	C302361	C302439	038713-000
SCE215C053/C063/C073	C304691	-	-
EFE215C053/C063/C073	-	C304699	-
SCE215C083	C304692	-	-
EFE215C083	-	C304700	-
EFE215B093	C302365	-	-

(1) Standard prefixes/suffixes are also applicable to kits.
- Not available

ORDERING EXAMPLES:

SC	E	215	C	010	230V / 50 Hz
SC	E	215	C	020	MB 115V / 50 Hz
EF	E	215	A	090	V 230V / 50 Hz
EF	E	215	B	070	24V / DC

prefix — pipe thread — basic number — voltage — suffix

ORDERING EXAMPLES KITS:

C302350 ⁽¹⁾	
C302352	V
C302432	J

basic number — suffix

DIMENSIONS (mm), WEIGHT (kg)



TYPE 01

Prefix "SC" Solenoid
Epoxy moulded
IEC 335 / ISO 4400
IP65

SCE215C010/C020/C030
SCE215A013/A023/A033

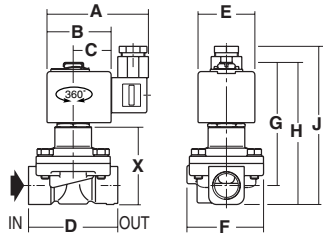

TYPE 02

Prefix "SC" Solenoid
Epoxy moulded
IEC 335 / ISO 4400
IP65

AC: SCE215B050/B060/B070/B080

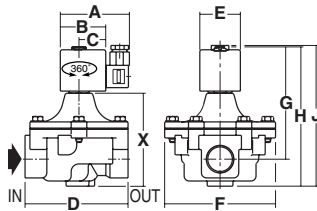

AC: SCE215C053/C063/C073/C083



TYPE 03

Prefix "EF" Solenoid
Epoxy encapsulated
ICS-6 ANSI
NEMA type 3-7-9

DC: EFE215B050/060/070/080
EFE215A090/A040

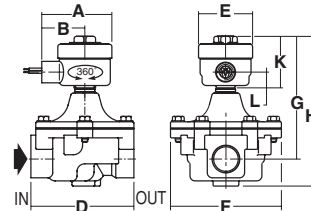

DC: EFE215C053/063/073/083
EFE215B093

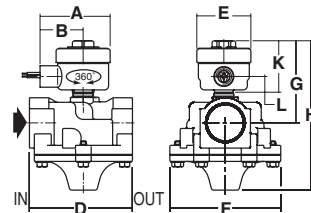
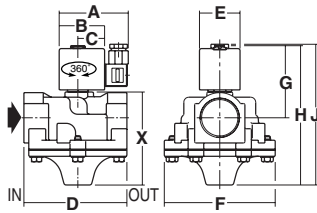

type	prefix option	catalogue number	A	B	C	D	E	F	G	H	J	K	L	X	weight ⁽²⁾
01	SC	SCE215C010/C020	80	50	30	70	45	60	88	102	119	-	-	53	0,6
		SCE215C030	80	50	30	84	45	60	93	113	130	-	-	59	0,7
		SCE215A013/A023	80	50	30	70	45	60	99	114	131	-	-	65	0,5
		SCE215A033	80	50	30	84	45	60	104	125	142	-	-	68	0,7
02	SC	SCE215B050/B060/B070	86	56	33	127	50	137	140	171	172	-	-	121	1,8
		SCE215B080	86	56	33	155	50	160	149	188	188	-	-	139	2,1
		SCE215C053/C063/C073	86	56	33	127	50	137	90	172	172	-	-	123	1,5
		SCE215C083	86	56	33	155	50	160	95	187	187	-	-	132	2,3
03	EF	EFE215B050/B060/B070	83	64	-	127	64	137	161	193	-	78	19	-	2,3
		EFE215B080	83	64	-	155	64	160	170	208	-	78	19	-	2,9
		EFE215C053/C063/C073	83	64	-	127	64	137	112	193	-	78	19	-	2,3
		EFE215C083	83	64	-	155	64	160	117	208	-	78	19	-	2,9
		EFE215A090/A040	83	64	-	198	64	202	194	253	-	78	19	-	5,0
		EFE215B093	83	64	-	198	64	202	125	255	-	78	19	-	5,0

(2) Incl. coil(s) and connector(s)

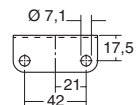

Mounting brackets for valves:

SCE215C010
SCE215C020
SCE215C030
SCE215A013
SCE215A023
SCE215A033

All leaflets are available on: www.asco.com